

MTG7_R

Combi Gas Oven - 7 (GN 1/1_ 60x40)



TECHNICAL FEATURES

- Heating of cooking chamber with atmospheric gas burner.
- Adjustable fan speed in 3 position.
- Double-glazed ventilated door (panels can be opened for easy cleaning).
- Cooking chamber lighting with LED.
- Adjustable door hinges.
- AISI 304 cooking chamber with rounded corners.
- Height adjustable feet.
- USB port for uploading and saving recipes and for firmware updating.
- Motorised vent valve opening
- Single control by means of just one jog/dial encoder knob.
- Wi-Fi included

OPTIONS:

- MTG7W Washing system included
- MTG7_L left side hinges
- MTG7_R right side hinges
- Optional rack for 60x40 trays.

USER INTERFACE:

TOUCH SCREEN PANEL 7"

Convection, steam, convection with steam in combi mode, humidification and dehumidification, cook with core probe, hold in temperature for overnight cooking.

These are the Easyair's functions, an oven line which is suitable to take either gastronom and confectionery size trays and containers.

OneTouch

To start with a single move the preferred recipes selected and memorized by him with the silhouette and the name he prefers.

RecipeTuner

The RecipeTuner interface makes it possible to modify and personalise the various programs simply and intuitively. RecipeTuner changes according to the type of cooking set, to regulate cooking, browning, degree of humidity and of leavening.

EasyService

level control cooking

The new Rack Control enables different dishes to be cooked at the same time at various levels. What's more, with EasyService, a new Rack Control function, all the dishes can be served at the same time.

1. On/Off switch.

2. Touch Screen Panel.

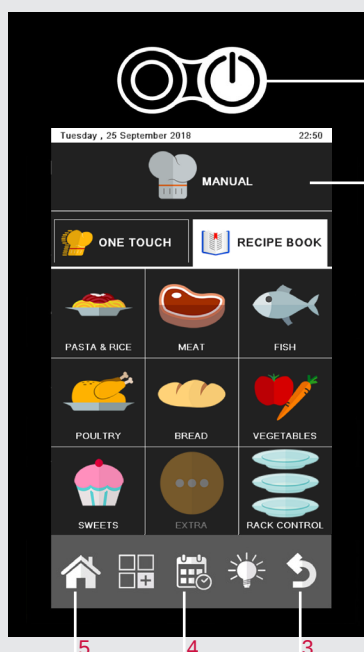

- Temperature control from 50° to 300°C
- Time control from 1' to 120'; infinite function.
- Cooking modes: convection, steam, combi convection/steam.

• "One Touch" cooking mode: immediate start of the cooking cycle with "one touch programs".

- Preset cooking programmes. Possibility of controlling 9 cooking phases for each programme.
- Cooking with "Rack Control"
- Interface "Recipe Tuner"
- Delta T cooking.
- Cooking with probe.
- Multi level cooking with "Easy service"
- Hold function.
- Cooldown during cooking.

• Cooking with "Rack Control"

• Interface "Recipe Tuner"

• Delta T cooking.

• Cooking with probe.

• Multi level cooking with "Easy service"

• Hold function.

•Cooldown during cooking.

3. Back Key

4. "Scheduled Departure" key.

5. Main Menu key.

MTG7_R
Combi Gas Oven - 7 (GN 1/1_ 60x40)

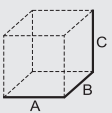
 (A x B x C) mm	VOL./PESO Vol./Weight m ³ /kg	VAC 230V-1N 50Hz (60 Hz optional) kW	POTENZA GAS CAMERA Oven cavity gas power kW	DISTANZA TRA LE TEGLIE Distance between the layers mm	DIM. CAMERA Cavity net dimension mm
...X...X... 7 GN 1/1 7 EN 60x40	0,82 / 130	0,6	16	74	645x600x450

ACCESSORIES

- Stand TSP1000
- Racks for stand TSP1000 cod. 2017692
- Proofer CLP0810
- Proofer CL900
- Proofer CL912
- Core probe 6000124 or multipoint core probe 6000126
- Probe for sous-vide cooking 6000117
- Hand spray 7080003

ACCESSORIES FOR PATISSERIE USE

- 2023824 racks 60x40 size 80.
- 2021519 racks 60x40 size 100

- A** Electrical connection
- B** Softened water inlet (G3/4)
- C** Equipotential bonding
- D** Drain (Ø30)
- E** Humidity discharge (Ø50)
- F** Detergent/Rinser hose inlet
- G** Smoke Exhaust (Ø124)
- H** Gas Inlet (R1/2)

WATER QUALITY REQUIREMENTS

Hardness	60-100 ppm
TDS	<100 mg/L
PH Value	7.0-8.0
Cl ₂ Free chlorine.....	<0,5 mg/L
Cl Chloride.....	<20 mg/L
Alkalinity.....	<20 mg/L
SiO ₂ Silica.....	<10 mg/L

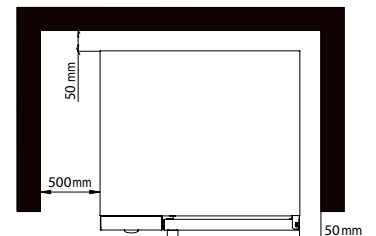
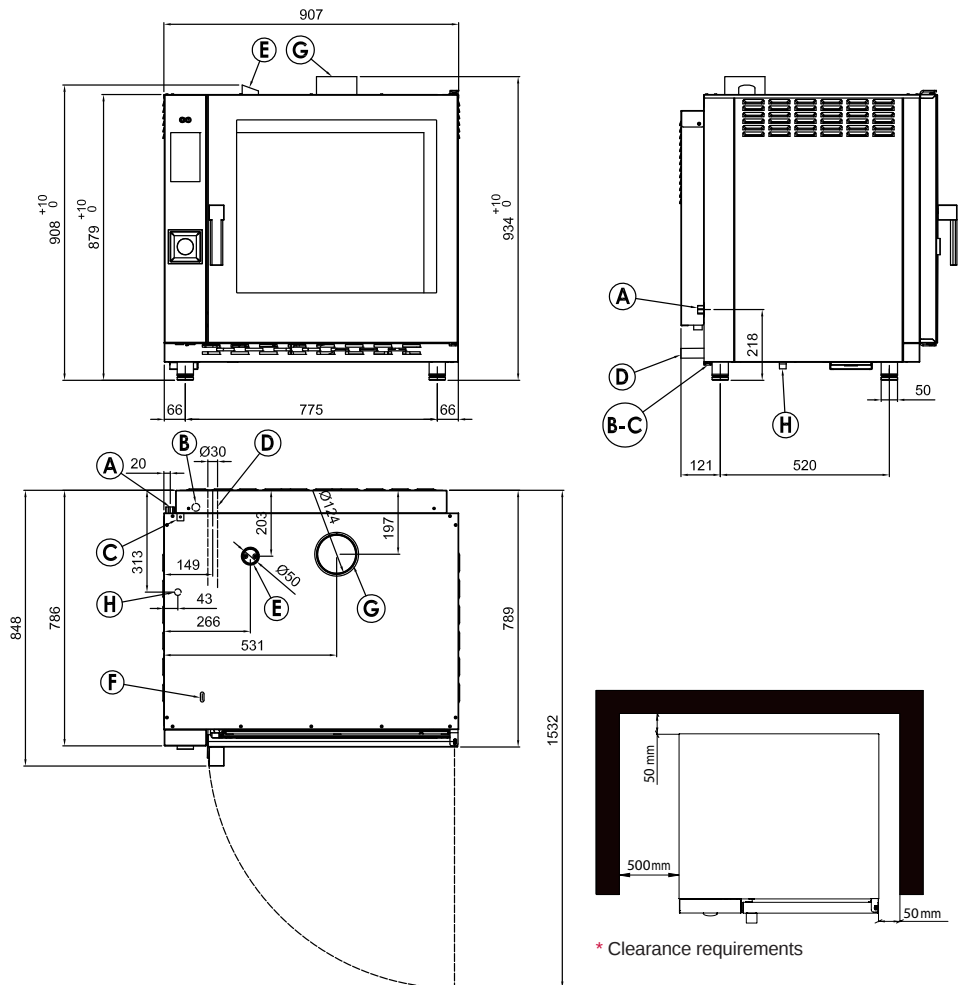

* Clearance requirements

NOTE

* Drain line must be vented

INSTALLATION REQUIREMENTS

The installation of gas ovens requires the analysis of combustion fumes, otherwise the warranty will be void. In addition, all installations (gas or electric) must always be adapted to local electrical systems and regulations on ventilation and plumbing connections.

WATER REQUIREMENTS and WATER CONNECTION

The following indicators may determine the validity or otherwise of the warranty.

Failure to comply with the minimum water requirements may cause corrosion and oxidation or technical problems, which can then cause a rapid decline in the performance and reliability of the appliances used to cook food.

The buyer is responsible for the water treatment procedures and must ensure that the incoming water meets the requirements tested and approved by Giorik below.



INCOMING WATER

Pressure (recommended)	1.5-3 bar (150-300 kPa)
PH	7.0-8.5
TDS (fixed residue)	40-150 mg/L)
Hardness (CaCO ₃)	3°f - 9°f (30-90 ppm; 1.5-5°d)
Langelier index	> 0.5

METAL SALT AND ION CONTENT

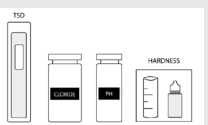
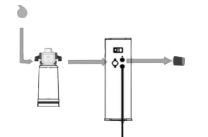

Cl Chlorides	< 20 mg/L
Sulphates + Nitrates	< 20 mg/L
Cl ₂ Chlorine free	< 0.1 mg/L
Chloramines	< 0.5 mg/L
Iron	< 0.1 mg/L
SiO ₂ Total Silica	< 10 mg/L

ACCESSORIES FOR WATER TESTING AND TREATMENT

	2027717	WATER ANALYSIS KIT Contains: conductivity meter, hardness test, 50 strips for pH testing and 40 strips for chloride testing
	7080556	COMPLETE REVERSE OSMOSIS SYSTEM Reverse osmosis system for obtaining pure water with almost complete separation of dissolved minerals, salts and other interfering substances. The chlorine filter and a storage tank are also included.
	7080558	LIMESCALE FILTRATION SYSTEM Filtration system for the optimisation of drinking water for the food and beverage sector. Reduces calcium, magnesium, unpleasant odours and chlorine. Composed of cartridge + head

DETERGENTS

In case of use of products for automatic oven washing other than official GIORIK products or in any case products approved by the manufacturer, the warranty will be considered void. Giorik cleaning products have in fact been developed and tested for Giorik ovens, and only if these are used is it possible to guarantee an adequate level of cleaning and an optimal life cycle for the oven and its components.

	7080542	GIORIK DEGREASE and RINSE 2 in 1 2 in 1 degreasing detergent and rinse aid for ovens with automatic washing
	7080533	** GIORIK BOILER DESCALER - Only for Ovens with Boiler
	7080537	DETERGENT AND DEGREASER for manual cleaning
	7080536	**TABS - Only for ovens with closed loop wash Evolution H and Kore B-I