

# BF-R031 BlastChiller ShockFreezer

## TECHNICAL FEATURES:

- Constructed in AISI 304 stainless steel, exterior with scotch-brite finish
- Interior radiused, in AISI 304 polished finish
- High density polyurethane foam insulation (approx. 42 kg/m<sup>3</sup>) 60 mm thick (50 mm mod 3 pans), HCFC-free
- Shaped internal bottom for containment, with central drain for washing and defrosting water
- Reversible door with special kit (except 3 levels)
- Ergonomic handle and magnetic gaskets on the 4 sides of the door
- Heating element to ensure perfect adherence of the door gasket.
- Door lock at 110 ° for inserting levels

## INTERNAL SETUP:

- Tray holder structure in AISI304 stainless steel, easily removable for easy cleaning
- Possibility to insert 3 GN1/1 levels, 67 mm pitch
- Microswitch that blocks the ventilation when the door is opened
- Conical core probe included

## FUNCTIONS:

- Pre-cooling
- Blast Chilling SOFT and HARD
- Shock Freezing SOFT and HARD
- Time control or with core probe
- Automatic storage at the end of the cycle
- Manual defrosting

## COOLING SYSTEM:

- Refrigerant gas R452A
- Standard air condensation
- Evaporator with anti-corrosion cataphoresis treatment, with multiple refrigerant gas injection points
- High thermal output condenser
- High performance hermetic compressor
- High pressure fans

## CONTROL BOARD:

- Electronic membrane control, programmable
- Real-time alarms



## SETUP:



3 LEVELS



530x325



REMOVABLE  
TRAYHOLDER + "C"  
SHAPED GUIDES



Electronic  
membrane control

## FEATURES:



STAINLESS STEEL  
AISI304

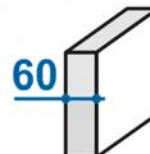

THICKNESS 60 mm

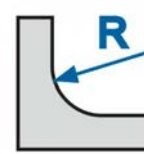

ROUNDED  
CORNERS

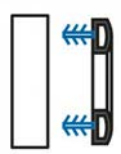

REMOVABLE  
DOOR GASKET  
WITHOUT  
TOOLS



INDIRECT  
AIRFLOW

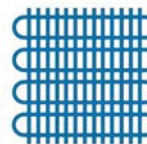

EVAPORATOR  
WITH  
CATAPHORESIS  
TREATMENT

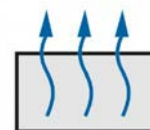

DEFROSTING WITH  
VENTILATION



CONICAL CORE  
PROBE

## PRIMAX Srl

Via Gemona, 14/16 - 33078 San Vito al Tagliamento (PN)  
Tel: +39 0434 630779 Fax: +39 0434 630956  
<https://www.primaxsrl.com> Email: [info@primaxsrl.com](mailto:info@primaxsrl.com)

# BF-R031 BlastChiller ShockFreezer

TECHNICAL SHEET	BF-R031
Measure pan mm	GN1/1
Total	3
Pitch mm	67
Trays insertion	Lengthwise
Net dimensions (LxWxH) mm	620x670x670
Depth with 90° door mm	1630
Door opening (WxH) mm	355x280
Net internal depth mm	540
Internal volume l	54.67
Insulation thickness mm	50
Insulated floor thickness mm	40
Net weight kg	52
Packing	Pallet + carton
Packaging dimensions (WxDxH) mm	640x690x820
Packing volume m3	0.36
Gross weight kg	60
Max power consumption KW	0.655
Max absorbed current A	3.13
Power supply V~/Hz	230/1/50
Electric cable n° x mm²	3x1,5mm²
Temperature range °C	-33/-36
Refrigeration system	Ventilated
Blast chilling yield +70°C-> +3°C within 90' kg/ciclo	8
Shock freezing yield +70°C->-18°C within 240' kg/ciclo	5
Refrigerant gas	R452A
Refrigerant gas quantity, water cooling g	410
Cooling power EN12900 W	379
Compressor hp	1/2
Defrosting	Forced ventilation
Climatic class	4

## PRIMAX Srl

Via Gemona, 14/16 - 33078 San Vito al Tagliamento (PN)  
Tel: +39 0434 630779 Fax: +39 0434 630956  
<https://www.primaxsrl.com> Email: [info@primaxsrl.com](mailto:info@primaxsrl.com)



# BF-R031 BlastChiller ShockFreezer

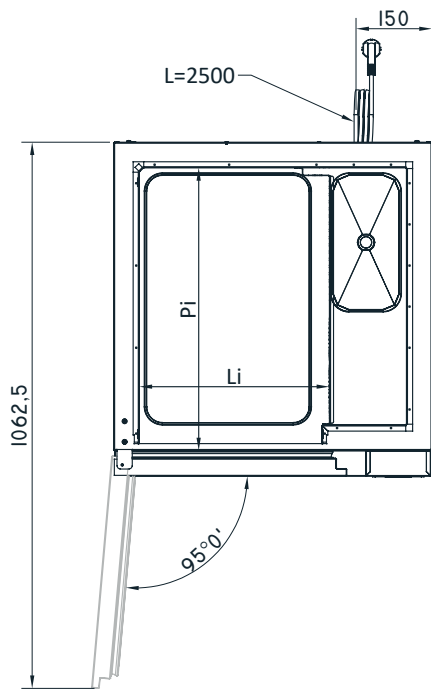
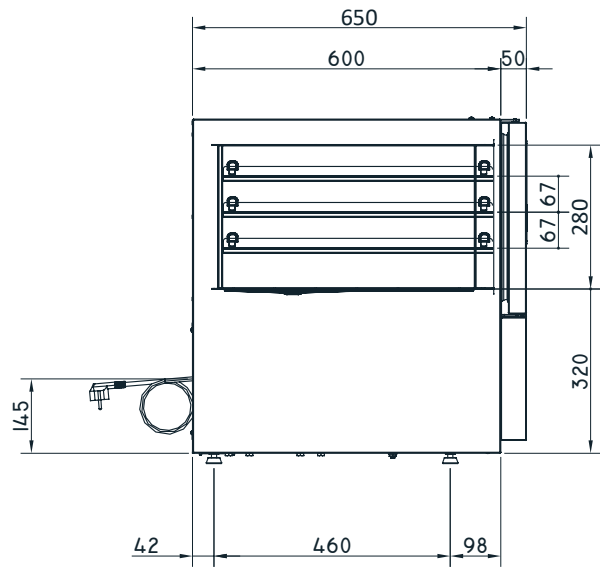
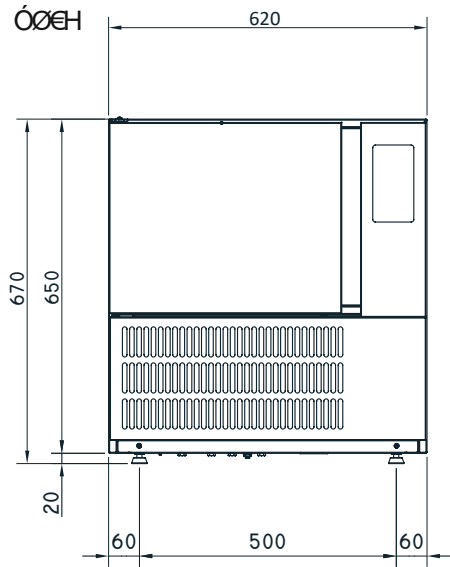

## DESCRIZIONE PANNELLO COMANDI CONTROL PANEL DESCRIPTION



	<b>Abbattimento positivo</b> <i>Blast chilling</i>
	<b>Tasto surgelazione</b> <i>Shock freezing</i>
	<b>Hard o soft</b> <i>Hard or soft</i>
	<b>Start / stop - On / Off</b>
	<b>Tasto incremento</b> <i>Increment key</i>
	<b>Tasto decremento</b> <i>Decrement</i>

3

Il costruttore declina ogni responsabilità a causa di errori e / o errori di stampa.