

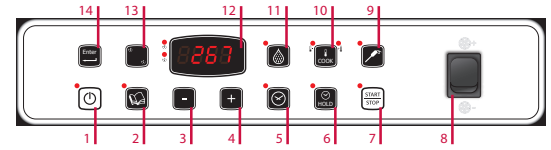

GR1411P

HOLDING-REGENERATING OVEN 14 (1/1 GN-600x400) PROGRAMMABLE VERSION

- Oven chamber heating by means of high-performance INCOLOY heating elements.
- Aisi 304 oven chamber with rounded corners.
- Reversing motor rotation for even cooking.
- Height-adjustable feet.
- 2 speed fan.
- 10 programs set with 2 cooking steps.
- Automatic preheating.
- Core probe.



- 1 On/Off switch.
- 2 Programs
- 3 Increase
- 4 Decrease
- 5 Timer
- 6 Hold function
- 7 Start/stop cycle
- 8 Select speed
- 9 Core-probe function
- 10 Set regenerating temperature
- 11 Humidifier
- 12 Display
- 13 Phase
- 14 Enter

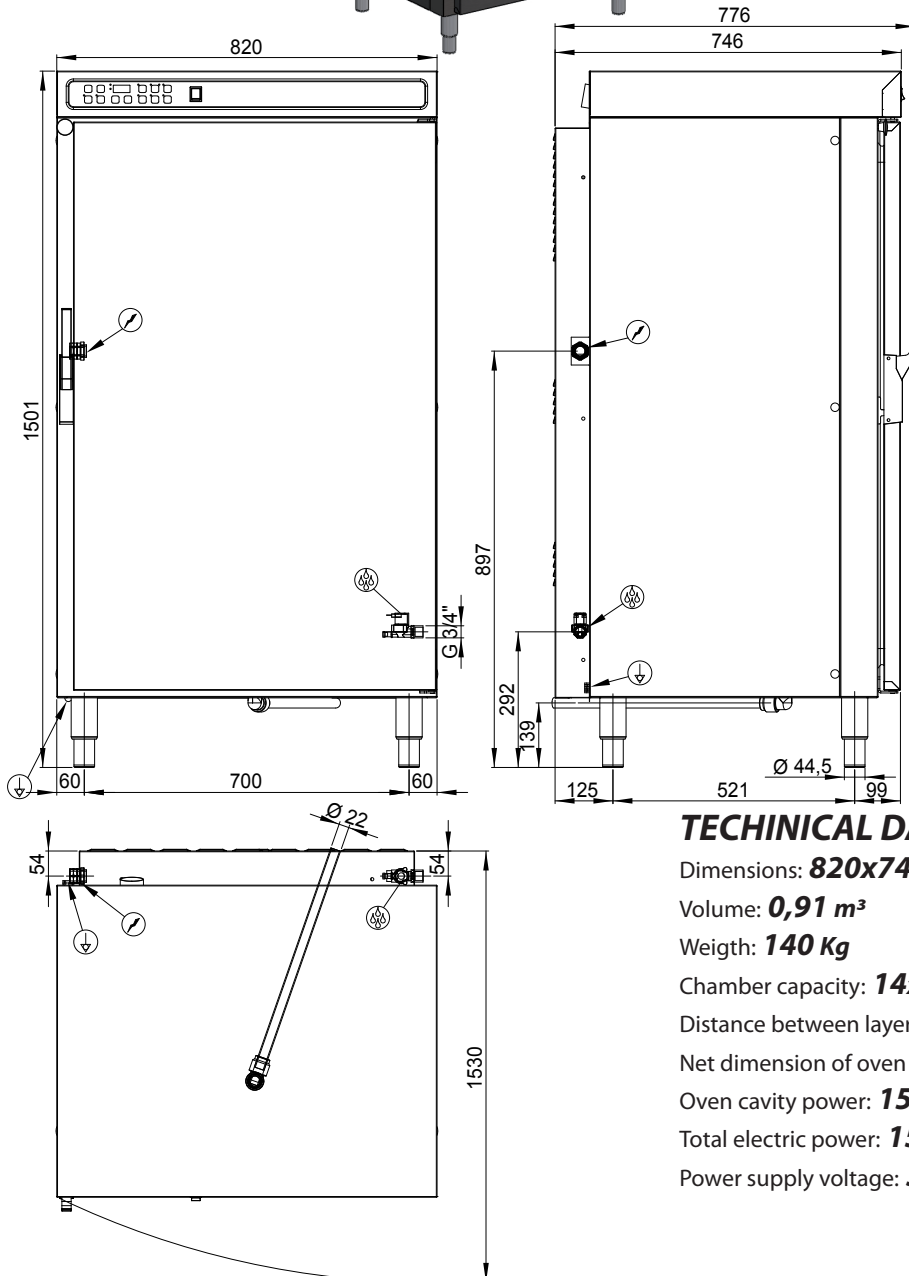

TECHINICAL DATA

Dimensions: **820x746x1501 mm**

Volume: **0,91 m³**

Weight: **140 Kg**

Chamber capacity: **14x(1/1 GN-600x400)**

Distance between layers: **74 mm**

Net dimension of oven cavity: **645x1100x450 mm (LxHxP)**

Oven cavity power: **15 kW**

Total electric power: **15,9 kW**

Power supply voltage: **3N 400V AC-50Hz**